

# Data Sheet



Article number: 2302151786

Description: Lobe knob  
VTT.50-SST-p-M10x40 CLEAN

## Measures

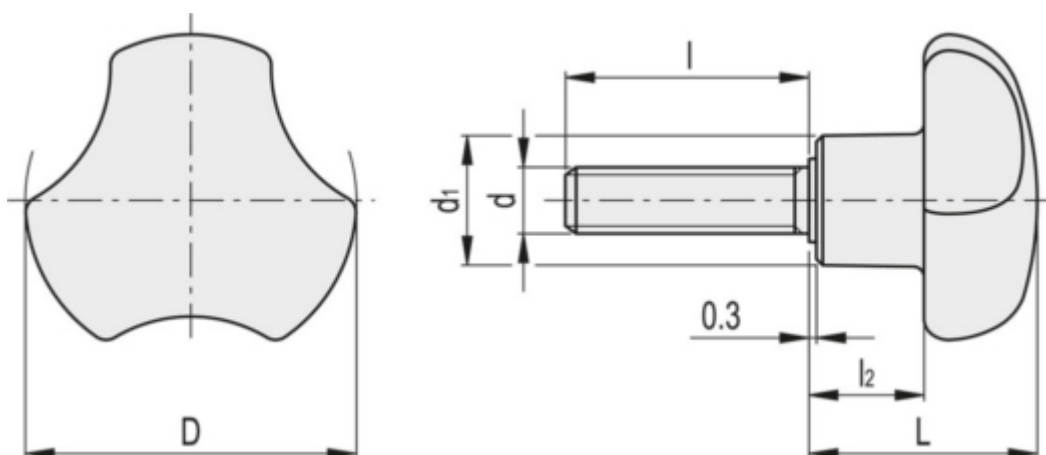

D	= 50
d1	= 19
Dg	= -
l2	= 15
L	= 30
L1	= 40
Weight in (g)	= 67